

Sprockets Asian standard series



Stock Bore Sprockets (NK) Asian Standard Series

NK 11SSB NK15B

NK 11SSB

SPROCKETS mm
Tooth width (T) 1.6

CHAIN mm
Pitch (P) 3.7465
Internal width 1.83
Roller Φ (Dr) 2.285

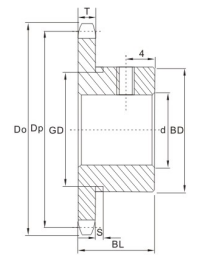
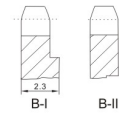

Type	Teeth	From	Do	Dp	Bore d		BD	BL	Set screw	Wt g	Material
					Min	Max					
NK 11SSB	12		162	144.75	4	6	94			5.9	SUS304 Solid
	15		199	180.20	4	9	13		M3 x 0.5	11.5	
	16		211	192.04	4	9	14			13.5	
	18	B-I	235	215.75	4	11	16			17.7	
	20		259	239.49	6	13	19			23.3	
	24		307	287.03	6	13	19			25.7	
	28		355	334.62	6	13	19	10.5		28.7	
	30		379	358.82						29.7	
	34		427	405.04					M4 x 0.7	37.9	
	36	B-II	151	429.86	6	13	19			40.7	
	40		498	477.51						46.5	
	48		594	572.83						60.5	

NK 15B

SPROCKETS mm
Tooth width (T) 2.0

CHAIN mm
Pitch (P) 4.7625
Internal width 2.38
Roller Φ (Dr) 2.48

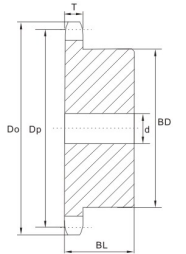

Type	Teeth	Do	Dp	Bore d		BD	BL	Wt g	Material
				Stock	Min				
NK 15B	11	19.0	16.90	4	5	7	11	10	9
	12	20.5	18.40	4	5	8	12	10	10
	13	22.0	19.90	4	5	9	14	10	14
	14	23.5	21.40	6	7	10	15	12	17
	15	25.0	22.91	6	7	12	17	12	22
	16	26.5	24.41	8	9	12	18	12	23
	17	28.0	25.92	8	9	14	20	14	32
	18	29.5	27.43	8	9	14	22	14	40
	19	31.0	28.93	8	9	15	23	14	44
	20	32.5	30.44	8	9	15	24	14	49
	21	34.0	31.95	8	9	17	26	14	57
	22	35.5	33.46	8	9	17	27	14	62
	23	37.5	34.98	8	9	17	28	14	68
	24	39.0	36.49	8	9	20	30	16	88
	25	40.5	38.00	8	9	20	32	16	100
	26	42.0	39.51	10	11	22	33	16	104
	27	43.5	41.02	10	11	25	35	16	117
	28	45.0	42.54	10	11	25	37	16	131
	29	46.5	44.05	10	11	25	38	16	139
	30	48.0	45.56	10	11	25	39	16	147
	31	49.5	47.08	10	11	25	40	18	175
	32	51.0	48.59	10	11	25	40	18	176
	33	52.5	50.10	10	11	25	40	18	178
	34	54.0	51.62	10	11	25	40	18	180
	35	55.5	53.13	10	11	25	40	18	182

B Type

Stock Bore Sprockets (NK)
Asian Standard Series

NK 25B

Type	Teeth	Do	Dp	Bore d		BD	BL	Wt g	Material	
				Stock	Min Max					
NK 25B	10	23	20.55	6.5	8.5	14	15	30	C45 Solid	
	11	25	22.54	6.5	8.5	15	15	30		
	12	28	24.53	7.5	9.5	15	15	30		
	13	30	26.53	7.5	9.5	18	15	50		
	14	32	28.54	7.5	9.5	20	15	50		
	15	34	30.54	7.5	9.5	20	15	50		
	16	36	32.55	9.5	11.5	12	25	15		60
	17	38	34.56	9.5	11.5	12	25	15		70
	18	40	36.57	9.5	11.5	12	25	15		70
	19	42	38.58	9.5	11.5	16	28	15		80
	20	44	40.59	9.5	11.5	16	28	15		80
	21	46	42.61	9.5	11.5	16	28	15		90
	22	48	44.65	9.5	11.5	16	30	15		100
	23	50	46.63	9.5	11.5	16	30	15		110
	24	52	48.65	9.5	11.5	16	30	15		120
	25	54	50.66	9.5	11.5	20	35	15		140
	26	56	52.68	9.5	11.5	20	35	15		140
	27	58	54.70	9.5	11.5	20	35	15		150
	28	60	56.71	9.5	11.5	20	35	15		150
	29	62	58.73	9.5	11.5	20	35	15		160
	30	64	60.75	9.5	11.5	20	35	15		160
	31	66	62.77	10.5	12.5	22	40	20		200
	32	68	64.78	10.5	12.5	22	40	20		200
	33	70	66.80	10.5	12.5	22	40	20		210
	34	72	68.82	10.5	12.5	22	40	20		210
	35	74	70.84	10.5	12.5	22	40	20		210
	36	76	72.86	10.5	12.5	22	40	20		220
	37	78	74.88	10.5	12.5	22	40	20		260
	38	80	76.90	10.5	12.5	22	40	20		260
	39	82	78.91	10.5	12.5	22	40	20		270
	40	84	80.93	10.5	12.5	22	40	20		270
	41	87	82.95	10.5	12.5	30	50	20		320
	42	89	84.97	10.5	12.5	30	50	20		320
	43	91	86.99	10.5	12.5	30	50	20		400
	44	93	89.01	10.5	12.5	30	50	20		410
	45	95	91.03	10.5	12.5	30	50	20		410
	48	101	97.09	10.5	12.5	30	50	20		430
	50	105	101.13	10.5	12.5	30	50	20		460
	54	113	109.21	10.5	12.5	30	50	20		470
	60	125	121.33	10.5	12.5	30	50	20		510
	65	135	131.43	11.5	13.5	30	50	20		720
	70	145	141.54	11.5	13.5	30	50	20		770
	75	155	151.64	11.5	13.5	30	50	20		820
	80	165	161.74	11.5	13.5	30	50	20		880

NK 25B
SPROCKETS mm
Tooth width (T) 2.8
CHAIN mm
Pitch (P) 6.35
Internal width 3.18
Roller Ø (Dr) 3.3

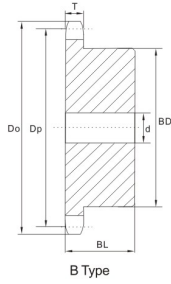

Stock Bore Sprockets (NK)
Asian Standard Series

NK 35B

Type	Teeth	Do	Dp	Bore d		BD	BL	Wt kg	Material
				Stock	Min Max				
NK 35B	9	32	27.85	8.5	10.5	11	★21.5	20	0.06
	10	34	30.82	8.5	10.5	12	★24.5	20	0.08
	11	38	33.81	9.5	11.5	14	★27	20	0.09
	12	41	36.81	9.5	11.5	16	★30.5	20	0.12
	13	44	39.80	9.5	11.5	18	★32	20	0.12
	14	47	42.81	9.5	11.5	18	★32	20	0.12
	15	51	45.81	9.5	11.5	20	35	20	0.16
	16	54	48.82	9.5	11.5	20	37	20	0.19
	17	57	51.84	11.5	13.5	25	41	20	0.22
	18	60	54.85	11.5	13.5	25	44	20	0.25
	19	63	57.87	11.5	13.5	28	47	20	0.28
	20	66	60.89	11.5	13.5	30	50	20	0.32
	21	69	63.91	11.5	13.5	32	53	20	0.36
	22	72	66.93	11.5	13.5	35	56	20	0.37
	23	75	69.95	11.5	13.5	38	60	20	0.38
	24	78	72.97	11.5	13.5	32	53	22	0.43
	25	81	76.00	11.5	13.5	32	53	22	0.44
	26	84	79.02	11.5	13.5	32	53	22	0.45
	27	87	82.05	11.5	13.5	32	53	22	0.46
	28	90	85.07	11.5	13.5	32	53	22	0.48
	29	93	88.10	11.5	13.5	32	53	22	0.49
	30	96	91.12	11.5	13.5	32	53	22	0.51
	31	99	94.15	11.5	13.5	32	53	22	0.53
	32	102	97.18	11.5	13.5	32	53	22	0.54
	33	105	100.20	11.5	13.5	32	53	22	0.56
	34	109	103.23	11.5	13.5	32	53	22	0.57
	35	112	106.26	11.5	13.5	32	53	22	0.59
	36	115	109.29	12.5	14.5	32	53	22	0.61
	37	118	112.31	12.5	14.5	42	63	25	0.80
	38	121	115.34	12.5	14.5	42	63	25	0.82
	39	124	118.37	12.5	14.5	42	63	25	0.84
	40	127	121.40	12.5	14.5	42	63	25	0.85
	41	130	124.43	16	18	42	63	25	0.91
	42	133	127.46	16	18	42	63	25	0.93
	43	136	130.49	16	18	42	63	25	0.95
	44	139	133.52	16	18	42	63	25	0.97
	45	142	136.55	16	18	42	63	25	1.00
	46	145	139.58	16	18	42	63	25	1.01
	47	148	142.61	16	18	42	63	25	1.03
	48	151	145.64	16	18	42	63	25	1.05
50	157	151.70	16	18	42	63	25	1.07	
53	166	160.78	16	18	42	63	25	1.09	
54	169	163.81	16	18	42	63	25	1.10	
55	172	166.85	16	18	42	63	25	1.25	
60	187	182.00	16	18	42	63	25	1.30	
64	200	194.12	16	18	42	63	25	1.46	
65	203	197.15	16	18	45	68	25	1.67	
70	218	212.30	16	18	45	68	25	1.80	
75	233	227.46	16	18	45	68	25	1.90	
80	248	242.61	16	18	45	68	25	2.40	

★Has recessed groove in hub for chain clearance

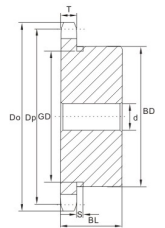

B Type Solid

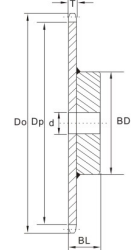

B Type Weld

Teeth	S	GD
9	4.4	17
10		20
11		23
12		26
13		29

Stock Bore Sprockets (NK)
Asian Standard Series

NK410B

NK 410B

SPROCKETS	mm
Tooth width (T)	2.8
CHAIN	
Pitch (P)	12.70
Internal width	3.40
Roller ϕ (Dr)	7.77



Type	Teeth	Do	Dp	Bore d			BD	BL	Wt kg	Material
				Stock	Min	Max				
NK 410B	10	46	41.10	9.5	11.5	16	28	20	0.14	C45 Solid
	11	51	45.08	10.5	12.5	16	30	20	0.19	
	12	55	49.07	11.5	13.5	18	34	20	0.22	
	13	59	53.07	13.5	15.5	20	38	20	0.23	
	14	63	57.07	13.5	15.5	25	42	20	0.28	
	15	67	61.08	13.5	15.5	28	46	20	0.34	
	16	71	65.10	13.5	15.5	30	50	20	0.40	
	17	76	69.12	13.5	15.5	32	54	22	0.46	
	18	80	73.14	13.5	15.5	35	57	22	0.51	
	19	84	77.16	13.5	15.5	40	62	22	0.59	
	20	88	81.18	14	16	45	67	25	0.76	
	21	92	85.21	14	16	48	71	25	0.85	
	22	96	89.24	14	16	51	75	25	0.95	
	23	100	93.27	14	16	51	77	25	1.00	
	24	104	97.30	14	16	42	63	25	0.84	
	25	108	101.33	14	16	42	63	25	0.88	
	26	112	105.36	14	16	42	63	25	0.92	
	27	116	109.40	14	16	42	63	25	0.96	
	28	120	113.43	14	16	42	63	25	1.00	
	29	124	117.46	14	16	42	63	25	1.00	
30	128	121.50	14	16	42	63	25	1.10		
32	137	129.57	14	16	45	68	28	1.30		
34	145	137.64	14	16	45	68	28	1.30		
35	149	141.68	14	16	45	68	28	1.40		
36	153	145.72	16	18	45	68	28	1.50		
40	169	161.87	16	18	45	68	28	1.70		

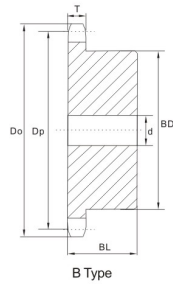

Stock Bore Sprockets (NK)
Asian Standard Series

NK 40B

Type	Teeth	Do	Dp	Bore d			BD	BL	Wt kg	Material
				Stock	Min	Max				
NK 40B	9	42	37.13	8.5	10.5	16	22	22	0.25	C45 Solid Hardened Teeth
	10	46	41.10	9.5	11.5	18	22	22	0.14	
	11	51	45.08	10.5	12.5	20	22	22	0.19	
	12	55	49.07	11.5	13.5	22	22	22	0.22	
	13	59	53.07	13.5	15.5	20	37	22	0.23	
	14	63	57.07	13.5	15.5	25	42	22	0.28	
	15	67	61.08	13.5	15.5	28	46	22	0.34	
	16	71	65.10	13.5	15.5	30	50	22	0.40	
	17	76	69.12	13.5	15.5	32	54	22	0.46	
	18	80	73.14	13.5	15.5	35	57	22	0.51	
	19	84	77.16	13.5	15.5	40	62	22	0.59	
	20	88	81.18	14	16	45	67	25	0.76	
	21	92	85.21	14	16	48	71	25	0.85	
	22	96	89.24	14	16	51	75	25	0.95	
	23	100	93.27	14	16	51	77	25	1.00	
	24	104	97.30	14	16	42	63	25	0.84	
	25	108	101.33	14	16	42	63	25	0.88	
	26	112	105.36	13	16	42	63	25	0.92	
	27	116	109.40	13	16	42	63	25	0.96	
	28	120	113.43	13	16	42	63	25	1.00	
	29	124	117.46	13	16	42	63	25	1.00	
	30	128	121.50	13	16	42	63	25	1.10	
	31	133	125.53	14	16	45	68	28	1.20	
	32	137	129.57	14	16	45	68	28	1.30	
	33	141	133.61	14	16	45	68	28	1.30	
	34	145	137.64	14	16	45	68	28	1.30	
	35	149	141.68	14	16	45	68	28	1.40	
	36	153	145.72	16	18	45	68	28	1.50	
	37	157	149.75	16	18	45	68	28	1.55	
	38	161	153.79	16	18	45	68	28	1.60	
	39	165	157.83	16	18	45	68	28	1.65	
	40	169	161.87	16	18	45	68	28	1.70	
	41	173	165.91	16	18	48	73	32	2.00	
	42	177	169.95	16	18	48	73	32	2.05	
	43	181	173.98	16	18	48	73	32	2.10	
	44	185	178.02	16	18	48	73	32	2.17	
	45	189	182.06	16	18	48	73	32	2.25	
	46	193	186.10	16	18	48	73	32	2.30	
	47	197	190.14	16	18	48	73	32	2.37	
	48	201	194.18	16	18	48	73	32	2.45	
49	205	198.22	16	18	48	73	32	2.51		
50	209	202.26	16	18	48	73	32	2.60		
51	214	206.30	16	18	48	73	32	2.65		
52	219	210.34	16	18	48	73	32	2.72		
53	222	214.38	16	18	48	73	32	2.80		
54	226	218.42	16	18	48	73	32	2.90		
55	230	222.46	16	18	48	73	32	2.96		
56	234	226.50	16	18	48	73	32	3.04		
60	250	242.66	16	18	48	73	32	3.40		
64	266	258.83	16	18	48	73	32	3.73		
65	270	262.87	16	18	55	83	32	4.10		
68	282	274.99	16	18	55	83	32	4.35		
70	290	283.07	16	18	55	83	32	4.57		
72	299	291.16	20	22	55	83	32	4.80		
75	311	303.28	20	22	55	83	32	5.10		
80	331	323.49	20	22	60	88	35	5.90		
85	351	343.69	20	22	60	88	35	6.50		
90	371	363.90	20	22	60	88	35	7.15		

NK 40B

SPROCKETS	mm
Tooth width (T)	7.2
CHAIN	
Pitch (P)	12.7
Internal width	7.95
Roller ϕ (Dr)	7.95

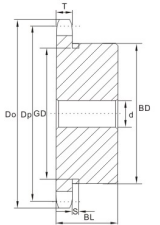

B Type Solid

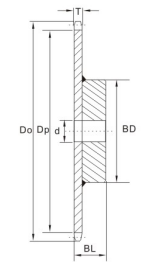

B Type Weld

Teeth	S	GD
9		23
10		27
11	5.2	31
31		31
12		35

★ Has recessed groove in hub for chain clearance

Stock Bore Sprockets (NK)
Asian Standard Series

NK 50B

Type	Teeth	Do	Dp	Bore d		BD	BL	Wt	Material
				Stock	Min Max				
NK 50B	8	48	41.48	11.5	13.5	13.5	★22	25	4.2
	9	53	46.42	11.5	13.5	18	★34	25	0.20
	10	58	51.37	14.5	16.5	22	★40	25	0.27
	11	64	56.35	14.5	16.5	28	★45.5	25	0.33
	12	69	61.34	14.5	16.5	30	★50	25	0.41
	13	74	66.34	14.5	16.5	32	★51	25	0.46
	14	79	71.34	14.5	16.5	32	52	25	0.52
	15	84	76.36	14.5	16.5	35	57	25	0.62
	16	89	81.37	14	16	40	62	25	0.72
	17	94	86.39	14	16	45	67	25	0.83
	18	100	91.42	14	16	48	72	28	1.00
	19	105	96.45	14	16	48	73	28	1.10
	20	110	101.48	14	16	48	73	28	1.20
	21	115	106.51	14	16	48	73	28	1.20
	22	120	111.55	16	18	48	73	28	1.30
	23	125	116.58	16	18	48	73	28	1.30
	24	130	121.62	16	18	48	73	28	1.40
	25	135	126.66	16	18	48	73	28	1.50
	26	140	131.70	16	18	48	73	28	1.50
	27	145	136.74	16	18	48	73	28	1.50
	28	150	141.79	16	18	48	73	28	1.60
	29	155	146.83	16	18	48	73	28	1.70
	30	161	151.87	16	18	48	73	28	1.80
	31	166	156.92	16	18	48	73	28	1.85
	32	171	161.96	16	18	48	73	28	1.90
	33	176	167.01	16	18	48	73	28	2.00
	34	181	172.05	16	18	48	73	28	2.10
	35	186	177.10	16	18	48	73	28	2.20
	36	191	182.14	16	18	55	83	35	2.85
	37	196	187.19	16	18	55	83	35	2.95
38	201	192.24	16	18	55	83	35	3.05	
39	206	197.29	16	18	55	83	35	3.15	
40	211	202.33	16	18	55	83	35	3.25	
41	216	207.38	16	18	55	83	35	3.40	
42	221	212.43	16	18	55	83	35	3.50	
43	226	217.48	16	18	55	83	35	3.60	
44	231	222.53	16	18	55	83	35	3.70	
45	237	227.58	16	18	55	83	35	3.85	
46	242	232.63	16	18	55	83	35	3.96	
47	247	237.68	16	18	55	83	35	4.09	
48	252	242.73	16	18	55	83	35	4.20	
49	257	247.78	16	18	55	83	35	4.35	
50	262	252.83	16	18	55	83	35	4.50	
51	267	257.88	16	18	55	83	35	4.62	
52	272	262.92	16	18	55	83	35	4.76	
53	277	267.97	16	18	55	83	35	4.91	
54	282	273.02	16	18	55	83	35	5.05	
55	287	278.08	16	18	55	83	35	5.20	
56	292	283.13	16	18	55	83	35	5.36	
57	297	288.18	16	18	55	83	35	5.51	
58	302	293.23	16	18	55	83	35	5.67	
60	312	303.33	16	18	55	83	35	6.00	
65	338	328.58	20	22	63	93	40	7.40	
68	353	343.74	20	22	63	93	40	7.94	
70	363	353.84	20	22	63	93	40	8.30	
75	388	379.10	20	22	63	93	40	9.35	
80	414	404.36	20	22	63	93	40	10.50	
85	439	429.62	20	22	63	93	40	12.00	
90	464	454.88	20	22	63	93	40	13.20	

NK 50B

SPROCKETS mm
Tooth width (T) 8.7

CHAIN mm
Pitch (P) 15.875
Internal width 9.53
Roller Ø (Dr) 10.16

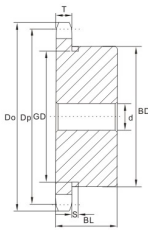

B Type Solid

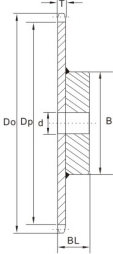

B Type Weld

Teeth	S	GD
8		22
9		29
10		34
11	64	39
12		44
13		49

★Has recessed groove in hub for chain clearance

Stock Bore Sprockets (NK)
Asian Standard Series

NK 60B

Type	Teeth	Do	Dp	Bore d		BD	BL	Wt	Material
				Stock	Min Max				
NK 60B	9	63	55.70	11.5	13.5	25	★43	32	0.40
	10	68	61.65	14.5	16.5	30	★49	32	0.49
	11	76	67.62	14.5	16.5	32	★51	32	0.60
	12	83	73.60	14.5	16.5	32	51	32	0.69
	13	89	79.60	14	16	35	57	32	0.71
	14	95	85.61	16	18	40	62	32	0.96
	15	101	91.62	16	18	45	68	32	1.10
	16	107	97.65	16	18	48	73	32	1.30
	17	113	103.67	16	18	48	73	32	1.40
	18	119	109.71	16	18	55	83	40	2.00
	19	126	115.74	16	18	55	83	40	2.10
	20	132	121.79	16	18	55	83	40	2.20
	21	138	127.82	16	18	55	83	40	2.30
	22	144	133.86	16	18	55	83	40	2.50
	23	150	139.90	16	18	55	83	40	2.50
	24	156	145.95	16	18	55	83	40	2.60
	25	162	151.99	16	18	55	83	40	2.70
	26	168	158.04	16	18	55	83	40	2.90
	27	174	164.09	20	22	55	83	40	3.00
	28	180	170.14	20	22	55	83	40	3.10
	29	187	176.20	20	22	55	83	40	3.30
	30	193	182.25	20	22	55	83	40	3.40
	31	199	188.30	20	22	55	83	40	3.64
	32	205	194.35	20	22	55	83	40	3.80
	33	211	200.41	20	22	55	83	40	4.00
	34	217	206.46	20	22	55	83	40	4.15
	35	223	212.52	20	22	55	83	40	4.33
	36	229	218.57	20	22	55	83	40	4.52
	37	235	224.63	20	22	55	83	40	4.70
	38	241	230.69	20	22	55	83	40	4.90
39	247	236.74	20	22	55	83	40	5.10	
40	253	242.80	20	22	55	83	40	5.30	
41	260	248.86	20	22	63	93	45	6.00	
42	266	254.92	20	22	63	93	45	6.40	
43	272	260.98	20	22	63	93	45	6.60	
44	278	267.03	20	22	63	93	45	6.88	
45	284	273.09	20	22	63	93	45	7.10	
46	290	279.15	20	22	63	93	45	7.28	
47	296	285.21	20	22	63	93	45	7.53	
48	302	291.27	20	22	63	93	45	7.85	
49	308	297.33	20	22	63	93	45	8.04	
50	314	303.39	20	22	63	93	45	8.40	
51	320	309.45	20	22	63	93	45	8.57	
52	326	315.51	20	22	63	93	45	8.94	
54	338	327.63	20	22	63	93	45	9.50	
55	345	333.69	20	22	63	93	45	9.69	
56	351	339.75	20	22	63	93	45	9.99	
58	363	351.87	20	22	63	93	45	10.59	
60	375	363.99	20	22	63	93	45	11.30	
64	399	388.24	20	22	63	93	45	12.50	
65	405	394.30	26	28	75	107	45	13.50	
70	436	424.61	26	28	75	107	45	15.30	
75	466	454.92	26	28	75	107	45	17.20	
80	496	485.23	26	28	80	117	50	20.00	
85	527	515.54	26	28	80	117	50	22.30	
90	557	545.85	26	28	80	117	50	24.60	

NK 60B

SPROCKETS mm
Tooth width (T) 11.7

CHAIN mm
Pitch (P) 19.05
Internal width 12.70
Roller Ø (Dr) 11.91

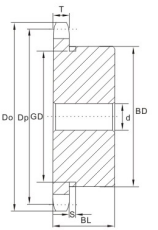

B Type Solid

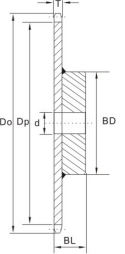

B Type Weld

Teeth	S	GD
9		32
10	80	37
11		45

★Has recessed groove in hub for chain clearance

Stock Bore Sprockets (NK)
Asian Standard Series

NK 80B

Type	Teeth	Do	Dp	Bore d		BD	BL	Wt kg	Material
				Stock	Min Max				
NK 80B	9	85	74.27	16	18 35	★58	40	0.87	C45 Solid Hardened Teeth
	10	93	82.19	16	18 32	52	40	1.02	
	11	102	90.16	16	18 38	60	40	1.25	
	12	110	98.14	16	18 45	67	40	1.60	
	13	118	106.14	16	18 51	77	40	1.90	
	14	127	114.15	16	18 51	77	40	2.15	
	15	135	122.17	20	22 63	93	40	2.30	
	16	143	130.20	20	22 63	93	40	2.50	
	17	151	138.23	20	22 63	93	40	2.95	
	18	159	146.27	20	22 63	93	40	3.15	
	19	167	154.32	20	22 63	93	40	3.40	
	20	176	162.37	20	22 63	93	40	3.60	
	21	184	170.42	20	22 63	93	40	3.85	
	22	192	178.48	26	28 75	107	45	5.00	
	23	200	186.54	26	28 75	107	45	5.23	
	24	208	194.60	26	28 75	107	45	5.50	
	25	216	202.66	26	28 75	107	45	5.80	
	26	224	210.72	26	28 75	107	45	6.10	
	27	233	218.79	26	28 75	107	45	6.40	
	28	241	226.86	26	28 75	107	45	6.75	
	29	249	234.93	26	28 75	107	45	7.10	
	30	257	243.00	26	28 75	107	45	7.40	
	31	265	251.07	26	28 75	107	45	7.80	
	32	273	259.14	26	28 75	107	45	8.15	
	33	281	267.21	26	28 75	107	45	8.50	
	34	289	275.29	26	28 75	107	45	8.90	
	35	297	283.36	26	28 75	107	45	9.30	
	36	306	291.43	26	28 80	117	50	10.60	
	37	314	299.51	26	28 80	117	50	11.00	
	38	322	307.58	26	28 80	117	50	11.40	
39	330	315.66	26	28 80	117	50	11.90		
40	338	323.74	26	28 80	117	50	12.40		
41	346	331.81	26	28 80	117	50	12.80		
42	354	339.89	26	28 80	117	50	13.30		
43	362	347.97	26	28 80	117	50	13.80		
44	370	356.04	26	28 80	117	50	14.30		
45	378	364.12	26	28 80	117	50	14.90		
46	387	372.20	26	28 80	117	50	15.30		
47	395	380.28	26	28 80	117	50	15.70		
48	403	388.36	26	28 80	117	50	15.80		
50	419	404.52	26	28 80	117	50	17.65		
52	435	420.68	26	28 80	117	50	18.70		
53	443	428.76	26	28 80	117	50	19.30		
54	451	436.84	26	28 80	117	50	20.00		
55	459	444.92	26	28 80	117	50	20.60		
56	468	453.00	26	28 80	117	50	21.30		
58	484	469.16	26	28 80	117	50	22.55		
60	500	485.33	26	28 80	117	50	23.10		
65	540	525.73	26	28 89	127	63	29.40		
70	581	566.15	26	28 89	127	63	32.10		
75	621	606.56	26	28 89	127	63	36.20		
80	662	646.97	26	28 95	127	71	42.90		
90	743	727.80	26	28 95	127	71	53.00		

NK 80B

SPROCKETS mm
Tooth width (T) 14.6

CHAIN mm
Pitch (P) 25.4
Internal width 15.88
Roller Ø (Dr) 15.88

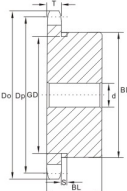

B Type Solid

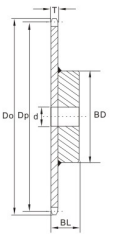

B Type Weld

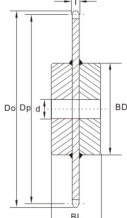

C Type Weld

Teeth	S	GD
9	10.4	44

★ Has recessed groove in hub for chain clearance

Stock Bore Sprockets (NK)
Asian Standard Series

NK 100B
NK 100C

NK 100B / NK 100C

SPROCKETS mm
Tooth width (T) 17.6

CHAIN mm
Pitch (P) 31.75
Internal width 19.05
Roller Ø (Dr) 19.05

Type	Teeth	Do	Dp	Bore d		BD	BL	Wt kg	Material
				Stock	Min Max				
NK 100B	9	106	92.84	20	22 40	★70	50	1.6	C45 Solid Hardened Teeth
	10	117	102.74	20	22 45	65	50	1.9	
	11	127	112.70	20	22 51	75	50	2.3	
	12	138	122.67	20	22 57	86	50	2.9	
	13	148	132.67	20	22 63	94	50	3.1	
	14	159	142.68	20	22 66	98	50	3.6	
	15	168	152.71	20	22 66	98	50	4.2	
	16	179	162.74	20	22 66	98	50	4.6	
	17	189	172.79	20	22 75	107	50	5.3	
	18	199	182.84	20	22 75	107	50	5.7	
	19	209	192.90	20	22 75	107	50	6.1	
	20	220	202.96	20	22 75	107	50	6.5	
	21	230	213.03	20	22 75	107	50	7.0	
	22	240	223.10	20	22 80	117	56	7.9	
	23	250	233.17	20	22 80	117	56	8.5	
	24	260	243.25	20	22 80	117	56	8.8	
	25	270	253.32	20	22 80	117	56	9.3	
	26	281	263.40	20	22 80	117	56	9.8	
	27	291	273.49	20	22 80	117	56	10.3	
	28	301	283.57	20	22 80	117	56	10.9	
	29	311	293.66	20	22 80	117	56	11.5	
	30	321	303.75	26	28 80	117	56	12.1	
	32	341	323.92	26	28 80	117	56	14.5	
	33	352	334.01	26	28 80	117	56	16.1	
	34	362	344.11	26	28 80	117	56	16.6	
	35	372	354.20	26	28 89	127	63	17.5	
	36	382	364.29	26	28 89	127	63	18.0	
	37	392	374.38	26	28 89	127	63	18.9	
	38	402	384.48	26	28 89	127	63	19.5	
	40	422	404.67	26	28 89	127	63	20.4	
41	433	414.77	26	28 89	127	63	21.5		
42	443	424.86	26	28 89	127	63	22.6		
45	473	455.16	26	28 89	127	63	24.7		
47	493	475.35	26	28 89	127	63	26.7		
48	503	485.45	26	28 89	127	63	27.5		
50	524	505.65	26	28 89	127	63	30.0		
54	564	546.05	26	28 103	147	80	37.6		
55	574	556.15	26	28 103	147	80	41.6		
60	625	606.66	26	28 103	147	80	44.3		
65	675	657.17	26	28 103	147	80	54.5		
70	726	707.68	26	28 103	147	100	64.7		
NK 100C	75	777	758.20	26	28 103	147	100	72.7	

Teeth	S	GD
9	11.5	55

★ Has recessed groove in hub for chain clearance

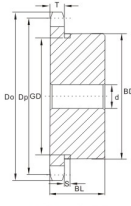

B Type Solid

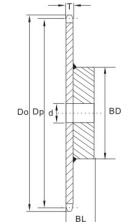

B Type Weld

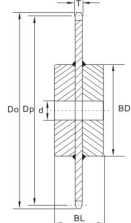

C Type Weld

ASIAN STANDARD SERIES

Stock Bore Sprockets (NK)
Asian Standard Series

NK 120B
NK 120C

NK 120B / NK 120C

SPROCKETS	mm
Teeth	23.5
CHAIN	mm
Pitch (P)	38.10
Internal width	25.40
Roller Φ (Dr)	22.23

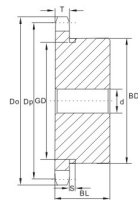

B Type Solid

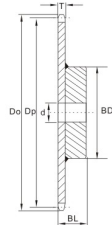

B Type Weld

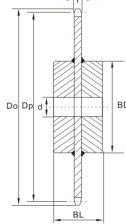

C Type Weld

Power Transmission Professional

Type	Teeth	Do	Dp	Bore d Stock	Min	Max	BD	BL	Wt kg	Material
NK 120B	10	140	123.29	20	22	51	78	56	3.20	C45 Solid Hardened Teeth
	11	153	135.24	20	22	60	91	56	4.00	
	12	165	147.21	20	22	66	98	56	4.80	
	13	177	159.20	20	22	66	98	56	5.30	
	14	190	171.22	20	22	75	107	56	6.30	
	15	202	183.25	20	22	80	117	63	7.80	
	16	214	195.29	20	22	80	117	63	8.40	
	17	227	207.35	20	22	80	117	63	9.10	
	18	239	219.41	20	22	80	117	63	9.90	
	19	251	231.48	20	22	80	117	63	10.70	
	20	263	243.55	20	22	89	127	63	12.10	
	21	276	255.63	20	22	89	127	63	13.00	
	22	288	267.72	26	28	89	127	63	13.40	
	23	300	279.80	26	28	89	127	63	14.50	
	24	312	291.90	26	28	89	127	63	15.20	
	25	324	303.99	26	28	89	127	63	16.20	
	26	337	316.09	26	28	89	127	63	17.20	
	28	361	340.29	26	28	95	137	71	20.90	
	30	385	364.50	26	28	95	137	71	23.20	
	32	410	388.71	26	28	95	137	71	25.70	
33	422	400.82	26	28	95	137	71	28.40		
34	434	412.93	26	28	95	137	71	29.00		
35	446	425.04	26	28	95	137	71	29.70		
36	458	437.15	26	28	95	137	71	32.00		
38	483	461.38	26	28	95	137	71	35.00		
40	507	485.60	26	28	103	147	80	38.20		
42	531	509.84	26	28	103	147	80	42.00		
45	568	546.19	26	28	103	147	80	47.60		
48	604	582.54	26	28	103	147	80	53.00		
50	628	606.78	26	28	103	147	80	58.00		
54	677	655.26	26	28	103	147	100	65.20		
NK 120C	60	750	727.99	26	28	103	167	100	78.00	Fe360 Welding

Stock Bore Sprockets (NK)
Asian Standard Series

NK 140B
NK 140C

NK 140B / NK 140C

SPROCKETS	mm
Teeth	23.5
CHAIN	mm
Pitch (P)	44.45
Internal width	25.22
Roller Φ (Dr)	25.40

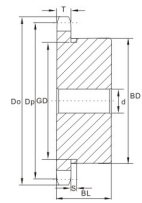

B Type Solid

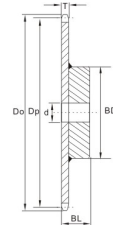

B Type Weld

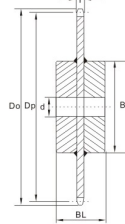

C Type Weld

Stock Bore

Type	Teeth	Do	Dp	Bore d Stock	Min	Max	BD	BL	Wt kg	Material
NK 140B	10	163	143.84	26	28	66	98	56	4.90	C45 Solid Hardened Teeth
	11	176	157.78	26	28	70	106	56	5.50	
	12	193	171.74	26	28	80	117	56	6.60	
	13	207	185.74	26	28	80	117	63	7.90	
	14	221	199.76	26	28	89	127	63	9.30	
	15	236	213.79	26	28	89	127	63	10.10	
	16	250	227.84	26	28	89	127	63	11.00	
	17	264	241.91	26	28	89	127	63	12.00	
	18	279	255.98	26	28	89	127	63	13.00	
	19	293	270.06	26	28	95	137	71	15.60	
	20	307	284.15	26	28	95	137	71	16.70	
	21	322	298.24	26	28	95	137	71	17.90	
	22	336	312.34	26	28	95	137	71	18.40	
	23	350	326.44	26	28	95	137	71	20.10	
	24	364	340.54	26	28	95	137	71	20.90	
	25	379	354.65	26	28	103	147	80	24.10	
	26	393	368.77	26	28	103	147	80	25.50	
	27	407	382.88	26	28	103	147	80	28.20	
	28	421	397.00	26	28	103	147	80	30.10	
	30	450	425.24	26	28	103	147	80	31.50	
32	478	453.49	26	28	103	147	80	36.00		
35	521	495.88	26	28	110	157	90	42.90		
36	535	510.01	26	28	110	157	90	47.40		
38	563	538.27	26	28	110	157	90	51.00		
40	591	566.54	26	28	110	157	90	53.10		
42	620	594.81	26	28	110	157	90	60.00		
45	662	637.22	26	28	118	167	100	69.00		
48	705	679.63	26	28	118	167	100	75.00		
50	733	707.91	26	28	118	167	100	85.30		
54	790	764.47	26	28	118	167	100	97.40		
NK 140C	60	875	849.32	26	28	118	167	112	119.30	Fe360 Welding

Stock Bore Sprockets (NK)
Asian Standard Series

NK 160B
NK 160C

NK 160B / NK 160C

SPROCKETS	mm
Tooth width (T)	29.4
CHAIN	mm
Pitch (P)	50.80
Internal width	31.55
Roller Φ (Dr)	28.58

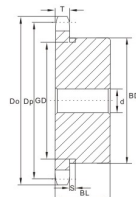

B Type Solid

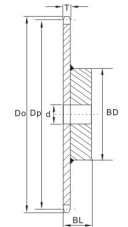

B Type Weld

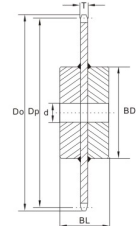

C Type Weld

Stock Bore

Type	Teeth	Do	Dp	Bore d			BD	BL	Wt kg	Material
				Stock	Min	Max				
NK 160B	10	186	164.39	26	28	70	105	63	6.80	C45 Solid Hardened Teeth
	11	204	180.31	26	28	80	117	63	8.30	
	12	220	196.28	26	28	89	127	63	9.90	
	13	237	212.27	26	28	95	137	71	12.50	
	14	253	228.30	26	28	95	137	71	13.80	
	15	269	244.33	26	28	95	137	71	15.20	
	16	286	260.39	26	28	103	147	71	17.40	
	17	302	276.46	26	28	103	147	71	18.90	
	18	319	292.55	26	28	103	147	71	20.60	
	19	335	308.64	26	28	103	147	71	22.30	
	20	351	324.74	26	28	103	147	71	24.20	
	21	368	340.84	26	28	103	147	71	26.10	
	22	384	356.96	26	28	118	167	80	30.20	
	24	416	389.19	26	28	118	167	80	34.40	
	25	433	405.32	26	28	118	167	80	36.60	
	26	449	421.45	26	28	118	167	80	38.90	
	30	514	485.99	26	28	118	167	100	52.30	
	32	546	518.28	26	28	118	167	100	59.00	
	35	595	566.71	26	28	118	167	100	66.90	
40	676	647.47	26	28	118	187	112	88.00		
NK 160C	45	757	728.25	26	28	132	187	125	115.00	Fe360 Welding
	48	806	776.72	26	28	132	187	125	128.00	
	50	838	809.04	26	28	132	187	125	130.70	
	54	903	873.68	26	28	132	187	125	158.40	
	60	1000	970.65	26	28	132	187	125	190.80	

Stock Bore Sprockets (NK)
Asian Standard Series

NK 180B
NK 180C

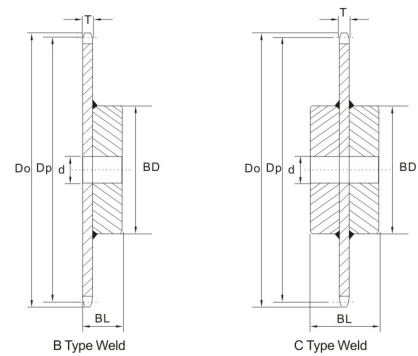

Power Transmission Professional

Type	Teeth	Do	Dp	Bore d			BD	BL	Wt kg	Material
				Stock	Min	Max				
NK 180B	11	229	202.85	43	45	75	110	55	9.3	Fe360 Welding
	12	248	220.81	43	45	85	130	65	12.6	
	13	266	238.81	43	45	95	150	75	16.6	
	14	285	256.83	43	45	105	170	80	20.9	
	15	303	274.87	43	45	110	180	80	23.8	
	16	322	292.94	43	45	110	180	80	25.9	
	17	340	311.01	43	45	115	180	80	28.1	
	18	358	329.11	43	45	115	180	80	29.9	
	19	377	347.21	43	45	115	180	80	32.4	
	20	395	365.33	43	45	115	180	80	35.0	
NK 180C	21	413	383.45	63	65	120	190	85	38.8	
	22	432	401.57	63	65	120	190	85	41.7	
	24	468	437.84	63	65	125	200	90	50.2	
	25	487	455.99	63	65	125	200	90	53.5	
	26	505	474.13	63	65	125	200	90	56.8	
	30	578	546.74	63	65	135	220	110	81.1	
	35	669	637.56	63	65	135	220	110	102.9	
	40	760	728.41	63	65	150	240	125	137.5	
	45	852	819.28	63	65	150	240	125	166.1	
	48	903	873.81	63	65	150	240	125	184.9	
60	1,125	1,091.98	63	65	150	240	125	272.2		

NK 180B / NK 180C

SPROCKETS	mm
Tooth width (T)	33.0
CHAIN	mm
Pitch (P)	57.15
Internal width	35.72
Roller Φ (Dr)	35.71

Stock Bore Sprockets (NK)
Asian Standard Series

NK 200B
NK 200C

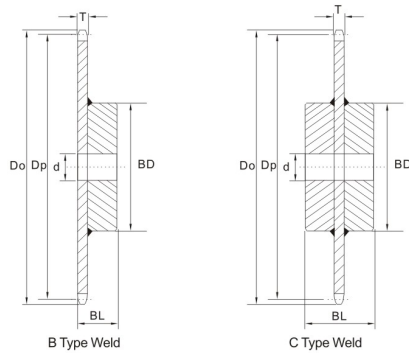

Stock Bore Sprockets (NK)
Asian Standard Series

NK 35-2B

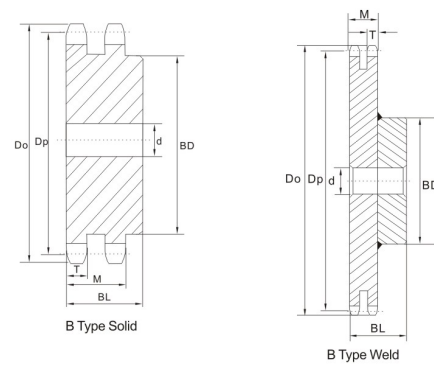

Power Transmission Professional

Type	Teeth	Do	Dp	Bore d			BD	BL	Wt g	Material
				Stock	Min	Max				
NK 200B	11	254	225.39	43	45	80	130	65	13.4	Fc360 Welding
	12	275	245.34	43	45	90	150	75	17.8	
	13	296	265.34	43	45	100	170	80	22.4	
	14	316	285.37	43	45	110	180	80	25.7	
	15	337	305.42	43	45	115	180	80	28.3	
	16	357	325.49	43	45	115	180	80	30.3	
	17	378	345.58	43	45	120	190	85	35.3	
	18	398	365.68	43	45	120	190	85	38.4	
NK 200C	19	419	385.79	63	65	125	200	90	42.9	
	20	439	405.92	63	65	125	200	90	46.4	
	21	459	426.05	63	65	135	220	110	59.1	
	22	480	446.20	63	65	135	220	110	62.2	
	24	520	486.49	63	65	140	230	110	73.1	
	25	541	506.65	63	65	140	230	110	77.5	
	26	561	526.81	63	65	140	230	110	82.0	
	30	642	607.49	63	65	150	240	125	109.1	
	35	744	708.39	63	65	150	240	125	138.0	
	40	845	809.34	63	65	170	270	140	186.1	
	45	946	910.31	63	65	170	270	140	223.9	
	48	1,007	970.90	68	70	170	270	140	248.2	
60	1,250	1,213.31	68	70	170	270	140	363.2		

NK 200B / NK 200C

SPROCKETS	
Tooth width (T)	mm 35.3
CHAIN	
Pitch (P)	mm 63.50
Internal width	mm 37.85
Roller Φ (Dr)	mm 39.68

Type	Teeth	Do	Dp	Bore d			BD	BL	Wt kg	Material
				Stock	Min	Max				
NK 35-2B	10	34	30.82	9	11	10	20	30	0.10	C45 Solid Hardened Teeth
	11	38	33.81	10	12	12	23	30	0.11	
	12	41	36.80	10	12	14	26	30	0.14	
	13	44	39.80	10	12	14	27	30	0.17	
	14	47	42.81	10	12	18	32	30	0.21	
	15	51	45.81	10	12	20	35	30	0.25	
	16	54	48.82	10	12	20	38	30	0.29	
	17	57	51.84	11.5	13.5	22	41	30	0.34	
	18	60	54.85	11.5	13.5	25	44	35	0.45	
	19	63	57.87	11.5	13.5	28	47	35	0.51	
	20	66	60.89	12	14	30	50	40	0.64	
	21	69	63.91	12	14	30	50	40	0.64	
	22	72	66.93	12	14	32	55	40	0.67	
	24	78	72.97	15	17	38	60	40	0.82	
	25	81	76.00	15	17	38	60	40	0.92	
	28	90	85.07	15	17	42	65	45	1.26	
	30	96	91.12	15	17	42	65	45	1.34	
	32	102	97.18	15	17	42	65	45	1.43	
	40	127	121.40	15	17	42	65	45	2.20	
	45	142	136.55	19	21	55	83	45	2.84	
50	157	151.70	19	21	55	83	45	3.22		
60	187	182.00	19	21	63	93	50	4.70		

Stock Bore
NK 35-2B

SPROCKETS	
Tooth width (T)	mm 4.1
CHAIN	
Pitch (P)	mm 9.525
Internal width	mm 4.78
Roller Φ (Dr)	mm 5.08

Stock Bore Sprockets (NK)
Asian Standard Series

NK 40-2B

NK 40-2B

SPROCKETS	mm
Teeth	7.0
CHAIN	mm
Pitch (P)	12.7
Internal width	7.95
Roller ϕ (Dr)	7.95

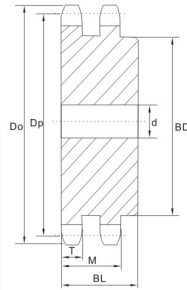

B Type Solid

Type	Teeth	Do	Dp	Bore d			BD	BL	Wt kg	Material
				Stock	Min	Max				
NK40-2B	10	46	41.10	13	15	16	28	35	0.28	C45 Solid Hardened Teeth
	11	51	45.08	13	15	16	30	35	0.30	
	12	55	49.07	14	16	20	35	35	0.34	
	13	59	53.07	14	16	22	39	35	0.40	
	14	63	57.07	14	16	25	43	35	0.47	
	15	67	61.08	14	16	28	47	35	0.55	
	16	71	65.10	14	16	30	50	35	0.65	
	17	76	69.12	14	16	32	54	35	0.75	
	18	80	73.14	14	16	38	59	35	0.85	
	19	84	77.16	14	16	42	63	35	0.98	
	20	88	81.18	14	16	45	67	40	1.30	
	21	92	85.21	14	16	45	68	40	1.30	
	22	96	89.24	14	16	48	72	40	1.50	
	23	100	93.27	14	16	51	76	40	1.60	
	24	104	97.30	14	16	55	80	40	1.80	
	25	108	101.33	18	20	57	84	40	2.00	
	26	112	105.36	18	20	60	88	40	2.20	
	27	116	109.40	18	20	60	92	40	2.30	
	28	120	113.43	18	20	66	96	40	2.50	
	29	124	117.46	18	20	66	96	40	2.65	
30	128	121.50	18	20	66	100	40	2.80		
31	133	125.53	23	25	66	100	50	2.95		
32	137	129.57	23	25	66	100	50	3.05		
33	141	133.61	23	25	66	100	50	3.06		
34	145	137.64	23	25	66	100	50	3.08		
35	149	141.68	23	25	66	100	50	3.10		
36	153	145.72	23	25	66	100	50	3.30		
37	157	149.75	23	25	66	100	50	3.40		
38	161	153.79	23	25	66	100	50	3.50		
40	169	161.87	23	25	66	100	50	3.60		
42	177	169.95	23	25	63	93	50	4.00		
45	189	182.06	23	25	63	93	50	4.60		
48	201	194.18	23	25	63	93	50	5.00		
50	209	202.26	23	25	63	93	50	5.50		
54	226	218.42	23	25	63	93	50	5.80		
60	250	242.66	23	25	63	93	50	6.70		
65	270	262.87	23	25	63	93	50	10.20		
70	290	283.07	23	25	63	93	50	11.50		

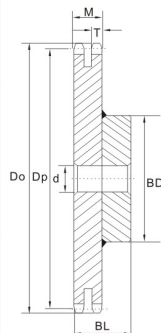

B Type Weld

Stock Bore Sprockets (NK)
Asian Standard Series

NK 50-2B

NK 50-2B

SPROCKETS	mm
Teeth	8.4
CHAIN	mm
Pitch (P)	15.875
Internal width	9.53
Roller ϕ (Dr)	10.16

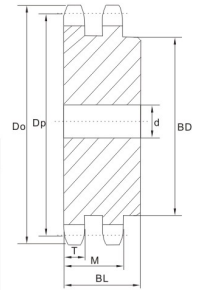

B Type Solid

Steel Bore

Type	Teeth	Do	Dp	Bore d			BD	BL	Wt kg	Material
				Stock	Min	Max				
NK50-2B	10	58	51.37	14	16	20	35	40	0.50	C45 Solid Hardened Teeth
	11	64	56.35	14	16	22	40	40	0.50	
	12	69	61.34	14	16	25	42	40	0.62	
	13	74	66.34	14	16	30	49	40	0.75	
	14	79	71.34	14	16	32	54	40	0.90	
	15	84	76.35	14	16	38	59	40	1.10	
	16	89	81.37	14	16	42	64	45	1.40	
	17	94	86.39	14	16	45	68	45	1.60	
	18	100	91.42	14	16	48	74	45	1.80	
	19	105	96.45	14	16	55	79	45	2.10	
	20	110	101.48	18	20	57	84	45	2.30	
	21	115	106.51	18	20	60	89	45	2.60	
	22	120	111.55	18	20	63	94	50	3.00	
	23	125	116.58	18	20	66	99	50	3.50	
	24	130	121.62	18	20	70	105	50	3.80	
	25	135	126.66	18	20	70	105	50	4.20	
	26	140	131.70	18	20	70	105	50	4.50	
	27	145	136.74	18	20	70	105	50	4.80	
	28	150	141.79	18	20	75	110	50	5.10	
	29	155	146.83	18	20	75	110	50	5.50	
30	161	151.87	18	20	80	120	50	5.80		
31	166	156.92	23	25	80	120	50	5.90		
32	171	161.96	23	25	80	120	50	6.00		
33	176	167.01	23	25	80	120	50	6.50		
34	181	172.05	23	25	80	120	50	6.80		
35	186	177.10	23	25	80	117	50	7.00		
36	191	182.14	23	25	80	117	50	7.00		
38	201	192.24	23	25	80	117	50	8.00		
40	211	202.33	23	25	80	117	56	9.00		
42	221	212.43	23	25	66	98	56	8.88		
45	237	227.58	23	25	66	98	56	9.96		
48	252	242.73	23	25	66	98	56	8.00		
50	262	252.83	23	25	66	98	56	9.00		
54	282	273.02	23	25	66	98	56	9.90		
60	312	303.33	23	25	66	98	56	11.70		
65	338	328.58	23	25	66	98	56	13.00		
70	363	353.84	23	25	66	98	56	15.00		

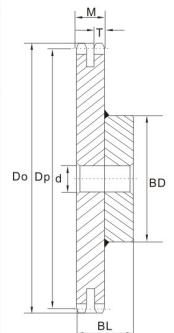

B Type Weld

Stock Bore Sprockets (NK)
Asian Standard Series

NK 60-2B

NK 60-2B

SPROCKETS	mm
Teeth	11.3
CHAIN	mm
Pitch (P)	19.05
Internal width	12.70
Roller ϕ (Dr)	11.91

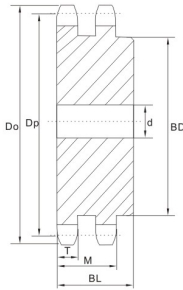

B Type Solid

Stock Bore

Type	Teeth	Do	Dp	Bore d		BD	BL	Wt kg	Material	
				Stock	Min Max					
NK 60-2B	10	68	61.65	16	18	20	35	50	0.90	C45 Solid Hardened Teeth
	11	76	67.62	16	18	25	44	50	1.00	
	12	83	73.60	16	18	30	50	50	1.20	
	13	89	79.60	18	20	35	57	50	1.40	
	14	95	85.61	18	20	42	64	56	1.80	
	15	101	91.62	18	20	46	70	56	2.10	
	16	107	97.65	18	20	51	76	56	2.50	
	17	113	103.67	18	20	55	82	56	2.60	
	18	119	109.71	18	20	60	88	56	3.20	
	19	126	115.74	18	20	63	94	56	3.70	
	20	132	121.78	23	25	66	100	56	4.20	
	21	138	127.82	23	25	66	100	56	4.40	
	22	144	133.86	23	25	66	100	56	4.90	
	23	150	139.90	23	25	66	100	56	4.70	
	24	156	145.95	23	25	80	120	56	6.00	
	25	162	151.99	23	25	80	120	56	6.40	
	26	168	158.04	23	25	80	120	56	6.80	
	27	174	164.09	23	25	80	120	56	7.30	
	28	180	170.14	23	25	80	120	56	7.80	
	29	187	176.20	28	30	80	120	56	8.20	
	30	193	182.25	28	30	89	130	56	9.00	
	31	199	188.30	28	30	89	127	56	9.30	
	32	205	194.35	28	30	89	127	56	9.50	
	33	211	200.41	28	30	89	127	56	9.70	
	34	217	206.46	28	30	89	127	56	10.50	
	35	223	212.52	28	30	89	127	56	11.00	
	36	229	218.57	28	30	66	98	56	8.50	
	38	241	230.69	28	30	66	98	56	9.00	
40	253	242.80	28	30	66	98	56	9.70		
42	266	254.92	28	30	75	107	56	11.00		
45	284	273.09	28	30	75	107	71	12.80		
48	302	291.27	28	30	75	107	71	14.00		
50	314	303.39	28	30	75	107	71	16.00		
54	338	327.63	28	30	75	107	71	18.00		
60	375	363.99	28	30	75	107	71	21.50		
65	405	394.30	28	30	75	107	71	24.00		
70	436	424.61	28	30	75	107	71	30.00		

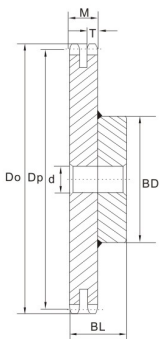

B Type Weld

Stock Bore Sprockets (NK)
Asian Standard Series

NK 80-2B

NK 80-2B

SPROCKETS	mm
Teeth	14.1
CHAIN	mm
Pitch (P)	25.4
Internal width	15.88
Roller ϕ (Dr)	15.88

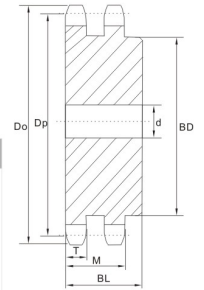

B Type Solid

Stock Bore

Type	Teeth	Do	Dp	Bore d		BD	BL	Wt kg	Material	
				Stock	Min Max					
NK 80-2B	10	93	82.19	21	23	35	58	63	2.00	C45 Solid Hardened Teeth
	11	102	90.16	21	23	38	60	63	2.50	
	12	110	98.14	23	25	46	69	63	2.70	
	13	118	106.14	23	25	55	80	63	3.40	
	14	127	114.15	23	25	60	88	63	3.90	
	15	135	122.17	23	25	63	95	63	4.40	
	16	143	130.20	23	25	66	100	71	5.40	
	17	151	138.23	23	25	66	100	71	6.00	
	18	159	146.27	23	25	80	120	71	7.50	
	19	167	154.32	23	25	80	120	71	8.00	
	20	176	162.37	23	25	89	130	71	9.00	
	21	184	170.42	23	25	89	130	71	10.30	
	22	192	178.48	33	35	80	117	71	11.00	
	23	200	186.54	33	35	80	117	71	11.80	
	24	208	194.60	33	35	80	117	80	12.60	
	25	216	202.66	33	35	80	117	80	13.40	
	26	224	210.72	33	35	80	117	80	14.20	
	28	241	226.96	33	35	80	117	80	16.00	
	30	257	243.00	33	35	80	117	80	18.30	
	32	273	259.14	33	35	80	117	80	20.40	
	35	297	283.36	33	35	80	117	80	23.90	
	36	306	291.43	33	35	80	117	80	25.10	
	38	322	307.58	38	40	90	127	80	27.70	
	40	338	323.74	38	40	90	127	90	30.40	
	42	354	339.89	38	40	90	127	90	33.00	
	45	378	364.12	38	40	90	127	90	37.50	
	48	403	388.36	38	40	90	127	90	43.00	
	50	419	404.52	38	40	90	127	90	46.00	
	54	451	436.84	38	40	90	127	90	52.50	
	60	500	485.33	38	40	90	127	90	64.00	
	62	516	501.49	38	40	90	127	90	69.00	
	65	540	525.73	38	40	90	127	90	73.50	
70	581	566.15	38	40	90	127	90	90.40		

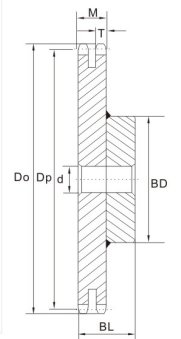

B Type Weld

Stock Bore Sprockets (NK)
Asian Standard Series

NK 100-2B
NK 100-2C

NK 100-2B/NK 100-2C

SPROCKETS _____ mm
Tooth width (T) 17.0

CHAIN _____ mm
Pitch (P) 31.75
Internal width 19.05
Roller Φ (Dr) 19.05

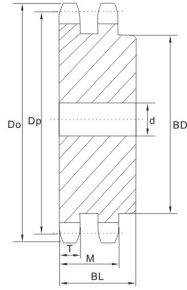

B Type Solid

Steel Bore

Type	Teeth	Do	Dp	Bore d		BD	BL	Wt kg	Material
				Stock	Min Max				
NK 100-2B	10	117	102.74	22	24 46	70	80	3.50	C45 Solid Hardened Teeth
	11	127	112.70	22	24 55	80	80	4.20	
	12	136	122.67	28	30 60	90	80	5.00	
	13	148	132.67	28	30 66	100	80	6.00	
	14	158	142.68	28	30 75	110	80	7.00	
	15	168	152.71	28	30 80	120	80	7.10	
	16	179	162.74	28	30 89	130	80	7.70	
	17	189	172.79	28	30 89	130	80	8.90	
	18	199	182.84	28	30 89	130	80	9.60	
	19	209	192.90	28	30 89	130	90	12.80	
	20	220	202.96	28	30 89	130	90	13.50	
	21	230	213.03	28	30 89	130	90	14.30	
	22	240	223.10	28	30 89	127	90	19.35	
	23	250	233.17	28	30 89	127	90	20.85	
	24	260	243.25	38	40 95	137	90	22.62	
	25	270	253.32	38	40 95	137	90	24.25	
	26	281	263.40	38	40 95	137	90	25.94	
	28	301	283.57	38	40 95	137	90	29.52	
30	321	303.75	38	40 95	137	90	33.37		
32	341	323.92	38	40 95	137	90	37.48		
35	372	354.20	38	40 95	137	90	44.15		
36	382	364.29	38	40 95	137	90	46.50		
38	402	384.48	38	40 95	137	90	51.41		
40	422	404.67	38	40 103	147	100	58.46		
42	443	424.86	38	40 103	147	100	63.90		
45	473	455.16	38	40 103	147	100	72.56		
48	503	485.45	38	40 103	147	100	81.81		
50	524	505.65	38	40 103	147	100	88.31		
54	564	546.05	38	40 103	147	100	102.11		
NK 100-2C	60	625	606.66	38	40 103	147	125	127.87	Fc360 Welding

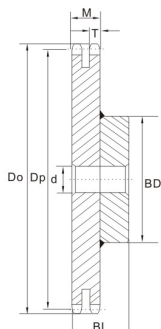

B Type Weld

Stock Bore Sprockets (NK)
Asian Standard Series

NK 120-2B
NK 120-2C

NK 120-2B/NK 120-2C

SPROCKETS _____ mm
Tooth width (T) 22.7

CHAIN _____ mm
Pitch (P) 38.10
Internal width 25.40
Roller Φ (Dr) 22.23

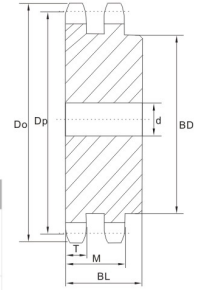

B Type Solid

Steel Bore

Type	Teeth	Do	Dp	Bore d		BD	BL	Wt kg	Material
				Stock	Min Max				
NK 120-2B	10	140	123.29	26	28 55	80	100	8.00	C45 Solid Hardened Teeth
	11	153	135.24	26	28 60	90	100	8.70	
	12	165	147.21	28	30 66	100	100	9.20	
	13	177	159.20	28	30 75	115	100	10.90	
	14	190	171.22	28	30 80	120	100	11.40	
	15	202	183.25	38	40 80	120	100	13.20	
	16	214	195.29	38	40 95	140	100	16.50	
	17	227	207.35	38	40 95	140	100	19.00	
	18	239	219.41	38	40 103	150	100	21.00	
	19	251	231.48	38	40 103	150	100	23.00	
	20	263	243.55	38	40 103	150	100	26.00	
	21	276	255.63	38	40 103	150	100	28.00	
	22	288	267.72	38	40 103	147	100	30.00	
	23	300	279.80	38	40 103	147	100	33.00	
	24	312	291.90	38	40 110	157	100	31.00	
	25	324	303.99	38	40 110	157	100	33.00	
	26	337	316.09	38	40 110	157	100	35.00	
	28	361	340.29	38	40 110	157	100	39.00	
30	385	364.50	38	40 110	157	100	43.90		
32	410	388.71	38	40 110	157	100	47.00		
35	446	425.04	38	40 110	157	100	56.80		
36	458	437.15	38	40 110	157	100	60.00		
38	483	461.38	38	40 110	157	100	67.00		
40	507	485.60	43	45 125	177	140	84.30		
42	531	509.84	43	45 125	177	140	87.00		
45	568	546.19	43	45 125	177	140	98.50		
48	604	582.54	43	45 125	177	140	104.00		
50	628	606.78	43	45 125	177	140	115.00		
54	677	655.26	43	45 125	177	140	121.00		
NK 120-2C	60	750	727.99	43	45 125	177	160	131.60	Fc360 Welding

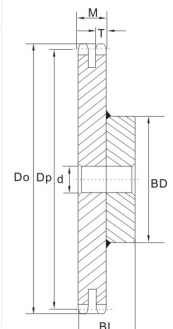

B Type Weld

Stock Bore Platewheels (K) Asian Standard Series

K 25A

K 25A

SPROCKETS mm
Tooth width (T) 2.8

CHAIN mm
Pitch (P) 6.35
Internal width 3.18
Roller Φ (Dr) 3.30

Type	Teeth	Do	Dp	Bore d		Wt kg	Material
				Stock	Min		
K 25A	10	23	20.55	9	11	0.02	C45 Solid
	12	28	24.53	9	11	0.03	
	13	30	26.53	9	11	0.04	
	14	32	28.54	9	11	0.04	
	15	34	30.54	9	11	0.05	
	16	36	32.55	9	11	0.05	
	17	38	34.56	9	11	0.07	
	18	40	36.57	9	11	0.07	
	20	44	40.59	9	11	0.09	
	24	52	48.65	9	11	0.14	
	25	54	50.66	9	11	0.16	
	27	58	54.70	9	11	0.17	
	28	60	56.71	9	11	0.18	
	29	62	58.73	9	11	0.20	
	30	64	60.75	10	12	0.23	
	32	68	64.78	10	12	0.27	
	33	70	66.80	10	12	0.28	
	35	74	70.84	10	12	0.30	
	36	76	72.86	10	12	0.32	
	37	78	74.88	10	12	0.37	
	38	80	76.90	10	12	0.41	
	40	84	80.93	11	13	0.43	
	42	89	84.97	11	13	0.47	
	45	95	91.03	11	13	0.50	
	50	105	101.13	11	13	0.59	
	55	115	111.23	11	13	0.70	
	60	125	121.33	11	13	0.87	
	70	145	141.54	11	13	1.81	
	75	155	151.64	12	14	1.37	
	80	165	161.74	12	14	1.62	

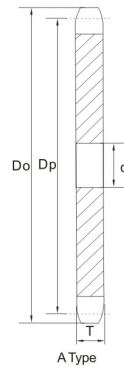

Stock Bore Platewheels (K) Asian Standard Series

K 35A

K 35A

SPROCKETS mm
Tooth width (T) 4.3

CHAIN mm
Pitch (P) 9.525
Internal width 4.78
Roller Φ (Dr) 5.08

Type	Teeth	Do	Dp	Bore d		Wt kg	Material
				Stock	Min		
K 35A	10	34	30.82	9	11	0.02	C45 Solid
	11	38	33.81	9	11	0.03	
	12	41	36.80	9	11	0.03	
	13	44	39.80	9	11	0.04	
	14	47	42.81	9	11	0.04	
	15	51	45.81	9	11	0.05	
	16	54	48.82	9	11	0.05	
	17	57	51.84	11	13	0.07	
	18	60	54.85	11	13	0.07	
	19	63	57.87	11	13	0.09	
	20	66	60.89	11	13	0.09	
	21	69	63.91	11	13	0.11	
	22	72	66.93	11	13	0.11	
	23	75	69.95	11	13	0.11	
	24	78	72.97	11	13	0.14	
	25	81	76.00	11	13	0.16	
	26	84	79.02	11	13	0.16	
	27	87	82.05	11	13	0.17	
	28	90	85.07	11	13	0.18	
	30	96	91.12	11	13	0.23	
	32	102	97.18	11	13	0.27	
	33	105	100.20	11	13	0.28	
	34	109	103.23	11	13	0.29	
	35	112	106.26	11	13	0.30	
	36	115	109.29	12	14	0.32	
	38	121	115.34	12	14	0.37	
	40	127	121.40	12	14	0.40	
	42	133	127.46	16	18	0.43	
	45	142	136.55	16	18	0.49	
	46	145	139.58	16	18	0.51	
	48	151	145.64	16	18	0.55	
	50	157	151.70	16	18	0.60	
54	169	163.81	16	18	0.70		
55	172	166.85	16	18	0.71		
60	187	182.00	16	18	0.80		
65	203	197.15	16	18	1.02		
70	218	212.30	16	18	1.18		
80	248	242.60	16	18	1.50		

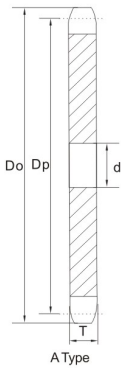

Stock Bore Platewheels (K)
Asian Standard Series

K 410A

Type	Teeth	Do	Dp	Bore d		Wt kg	Material
				Stock	Min		
K 410A	8	38	33.19	10	12	0.01	C45 Solid
	9	42	37.13	10	12	0.02	
	10	46	41.10	11	13	0.05	
	11	51	45.08	12	14	0.09	
	12	55	49.07	12	14	0.10	
	13	59	53.07	15	17	0.12	
	14	63	57.07	15	17	0.14	
	15	67	61.08	15	17	0.16	
	16	71	65.10	15	17	0.18	
	17	76	69.12	15	17	0.20	
	18	80	73.14	15	17	0.23	
	19	84	77.16	15	17	0.26	
	20	88	81.18	16	18	0.29	
	21	92	85.21	16	18	0.30	
	22	96	89.24	16	18	0.35	
	23	100	93.27	16	18	0.38	
	24	104	97.30	16	18	0.40	
	25	108	101.33	16	18	0.45	
	26	112	105.36	16	18	0.49	
	27	116	109.40	16	18	0.50	
	28	120	113.43	16	18	0.56	
	29	124	117.46	16	18	0.60	
	30	128	121.50	16	18	0.63	
	31	133	125.53	16	18	0.65	
	32	137	129.57	16	18	0.70	
	33	141	133.61	16	18	0.75	
	34	145	137.64	16	18	0.80	
	35	149	141.68	16	18	0.85	
	36	153	145.72	18	20	0.90	
	37	157	149.75	18	20	0.99	
	38	161	153.79	18	20	1.00	
	39	165	157.83	18	20	1.18	
	40	169	161.87	18	20	1.20	
	41	173	165.91	18	20	1.20	
	42	177	169.94	18	20	1.25	
	44	185	178.02	18	20	1.35	
45	189	182.06	18	20	1.40		
46	193	186.10	18	20	1.49		
47	197	190.14	18	20	1.58		
48	201	194.18	18	20	1.63		
49	205	198.22	18	20	1.73		
50	209	202.26	18	20	1.80		
51	214	206.30	16	18	1.88		
52	218	210.34	16	18	1.93		
53	222	214.38	16	18	1.98		
54	226	218.42	16	18	2.00		
55	230	222.46	16	18	2.18		
56	234	226.50	16	18	2.26		
58	242	234.58	16	18	2.43		
59	246	238.62	16	18	2.51		
60	250	242.66	16	18	2.60		
62	258	250.74	16	18	2.77		
64	266	258.83	16	18	2.90		
65	270	262.87	16	18	3.00		
68	282	274.99	16	18	3.35		
70	290	283.07	16	18	3.50		
72	299	291.16	20	22	3.70		
75	311	303.28	20	22	4.00		
80	331	323.49	20	22	4.60		
85	351	343.69	20	22	5.20		
90	371	363.90	20	22	5.88		

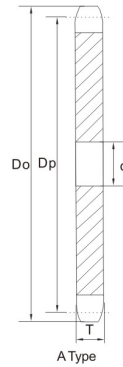

A Type

K 410A
 SPROCKETS mm
 Tooth width (T) 2.8
 CHAIN mm
 Pitch (P) 12.70
 Internal width 3.40
 Roller Φ (Dr) 7.75

Stock Bore Platewheels (K)
Asian Standard Series

K 40A

Type	Teeth	Do	Dp	Bore d		Wt kg	Material
				Stock	Min		
K 40A	10	46	41.10	9.5	11.5	0.05	C45 Solid
	11	51	45.08	10.5	12.5	0.09	
	12	55	49.07	11.5	13.5	0.10	
	13	59	53.07	13.5	15.5	0.12	
	14	63	57.07	13.5	15.5	0.14	
	15	67	61.08	13.5	15.5	0.16	
	16	71	65.10	13.5	15.5	0.18	
	17	76	69.12	13.5	15.5	0.20	
	18	80	73.14	13.5	15.5	0.23	
	19	84	77.16	13.5	15.5	0.26	
	20	88	81.18	14	16	0.29	
	21	92	85.21	14	16	0.30	
	22	96	89.24	14	16	0.35	
	23	100	93.27	14	16	0.38	
	24	104	97.30	14	16	0.40	
	25	108	101.33	14	16	0.45	
	26	112	105.36	14	16	0.49	
	27	116	109.40	14	16	0.50	
	28	120	113.43	14	16	0.56	
	29	124	117.46	14	16	0.60	
	30	128	121.50	14	16	0.63	
	31	133	125.53	14	16	0.65	
	32	137	129.57	14	16	0.70	
	33	141	133.61	14	16	0.75	
	34	145	137.64	14	16	0.80	
	35	149	141.68	14	16	0.85	
	36	153	145.72	16	18	0.90	
	37	157	149.75	16	18	0.99	
	38	161	153.79	16	18	1.00	
	39	165	157.83	16	18	1.15	
	40	169	161.87	16	18	1.20	
	41	173	165.91	16	18	1.20	
	42	177	169.94	16	18	1.25	
	43	181	173.98	16	18	1.30	
	44	185	178.02	16	18	1.35	
	45	189	182.06	16	18	1.40	
46	193	186.10	16	18	1.49		
47	197	190.14	16	18	1.58		
48	201	194.18	16	18	1.63		
49	205	198.22	16	18	1.73		
50	209	202.26	16	18	1.80		
51	214	206.30	16	18	1.88		
52	218	210.34	16	18	1.93		
53	222	214.38	16	18	1.98		
54	226	218.42	16	18	2.00		
55	230	222.46	16	18	2.18		
56	234	226.50	16	18	2.26		
58	242	234.58	16	18	2.43		
59	246	238.62	16	18	2.51		
60	250	242.66	16	18	2.60		
62	258	250.74	16	18	2.77		
64	266	258.83	16	18	2.90		
65	270	262.87	16	18	3.00		
68	282	274.99	16	18	3.35		
70	290	283.07	16	18	3.50		
72	299	291.16	20	22	3.70		
75	311	303.28	20	22	4.00		
80	331	323.49	20	22	4.60		
85	351	343.69	20	22	5.20		
90	371	363.90	20	22	5.88		

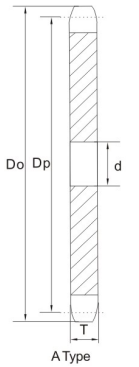

A Type

K 40A
 SPROCKETS mm
 Tooth width (T) 7.2
 CHAIN mm
 Pitch (P) 12.7
 Internal width 7.95
 Roller Φ (Dr) 7.95

Stock Bore Platewheels (K)
Asian Standard Series

K 50A

Type	Teeth	Do	Dp	Bore d		Wt kg	Material
				Stock	Min		
K 50A	10	58	51.37	14	16	0.14	C45 Solid
	11	64	56.35	14	16	0.17	
	12	69	61.34	14	16	0.20	
	13	74	66.34	14	16	0.23	
	14	79	71.34	14	16	0.27	
	15	84	76.35	14	16	0.30	
	16	89	81.37	14	16	0.35	
	17	94	86.39	14	16	0.40	
	18	100	91.42	14	16	0.45	
	19	105	96.45	14	16	0.48	
	20	110	101.48	14	16	0.50	
	21	115	106.51	14	16	0.60	
	22	120	111.55	16	18	0.66	
	23	125	116.58	16	18	0.72	
	24	130	121.62	16	18	0.78	
	25	135	126.66	16	18	0.85	
	26	140	131.70	16	18	0.90	
	27	145	136.74	16	18	1.00	
	28	150	141.79	16	18	1.05	
	29	155	146.83	16	18	1.12	
	30	161	151.87	16	18	1.20	
	31	166	156.92	16	18	1.30	
	32	171	161.96	16	18	1.35	
	33	176	167.01	16	18	1.45	
	34	181	172.05	16	18	1.55	
	35	186	177.10	16	18	1.65	
	36	191	182.14	16	18	1.75	
	37	196	187.19	16	18	1.85	
	38	201	192.24	16	18	1.95	
	39	206	197.29	16	18	2.05	
	40	211	202.33	16	18	2.15	
	41	216	207.38	16	18	2.25	
	42	221	212.43	16	18	2.40	
	43	226	217.48	16	18	2.50	
	44	231	222.53	16	18	2.60	
	45	237	227.58	16	18	2.70	
	46	242	232.63	16	18	2.88	
	47	247	237.68	16	18	3.01	
	48	252	242.73	16	18	3.10	
	49	257	247.78	16	18	3.27	
	50	262	252.83	16	18	3.40	
	51	267	257.88	16	18	3.55	
	52	272	262.92	16	18	3.69	
	53	277	267.97	16	18	3.83	
	54	282	273.02	16	18	3.95	
	55	287	278.08	16	18	4.13	
	56	292	283.13	16	18	4.28	
	57	297	288.18	16	18	4.44	
	58	302	293.23	16	18	4.59	
	59	307	298.28	16	18	4.75	
	60	312	303.33	16	18	4.90	
	64	333	323.53	20	22	5.60	
	65	338	328.58	20	22	5.75	
	68	353	343.74	20	22	6.32	
	70	363	353.84	20	22	6.70	
	72	373	363.94	20	22	7.05	
	75	388	379.10	20	22	7.70	
	80	414	404.36	20	22	8.70	
	90	464	454.88	20	22	11.00	

K 50A
 SPROCKETS mm
 Tooth width (T) 8.7
 CHAIN mm
 Pitch (P) 15.875
 Internal width 9.53
 Roller Φ (Dr) 10.16

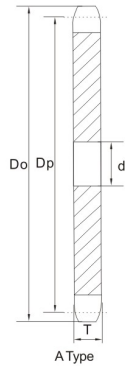

Stock Bore Platewheels (K)
Asian Standard Series

K 60A

Type	Teeth	Do	Dp	Bore d		Wt kg	Material
				Stock	Min		
K 60A	10	68	61.65	14	16	0.27	C45 Solid
	11	76	67.62	14	16	0.30	
	12	83	73.60	14	16	0.38	
	13	89	79.60	14	16	0.45	
	14	95	85.61	16	18	0.50	
	15	101	91.62	16	18	0.60	
	16	107	97.65	16	18	0.65	
	17	113	103.67	16	18	0.75	
	18	119	109.71	16	18	0.84	
	19	126	115.74	16	18	0.93	
	20	132	121.78	16	18	1.05	
	21	138	127.82	16	18	1.15	
	22	144	133.86	16	18	1.25	
	23	150	139.90	16	18	1.40	
	24	156	145.95	16	18	1.50	
	25	162	151.99	16	18	1.62	
	26	168	158.04	16	18	1.78	
	27	174	164.09	20	22	1.90	
	28	180	170.14	20	22	2.05	
	29	187	176.20	20	22	2.20	
	30	193	182.25	20	22	2.35	
	31	199	188.30	20	22	2.50	
	32	205	194.35	20	22	2.68	
	33	211	200.41	20	22	2.85	
	34	217	206.46	20	22	3.02	
	35	223	212.52	20	22	3.25	
	36	229	218.57	20	22	3.40	
	37	235	224.63	20	22	3.60	
	38	241	230.69	20	22	3.80	
	39	247	236.74	20	22	4.00	
	40	253	242.80	20	22	4.20	
	41	260	248.86	20	22	4.45	
	42	266	254.92	20	22	4.68	
	43	272	260.98	20	22	4.85	
	44	278	267.03	20	22	5.10	
	45	284	273.09	20	22	5.30	
	46	290	279.15	20	22	5.59	
	47	296	285.21	20	22	5.83	
	48	302	291.27	20	22	6.10	
	49	308	297.33	20	22	6.34	
	50	314	303.39	20	22	6.60	
	51	320	309.45	20	22	6.87	
	52	326	315.51	20	22	7.15	
	54	338	327.63	20	22	7.70	
	55	345	333.69	20	22	8.00	
	57	357	345.81	20	22	8.59	
	58	363	351.87	20	22	8.90	
	60	375	363.99	20	22	9.50	
	65	405	394.30	26	28	11.20	
	70	436	424.61	26	28	13.00	
	72	448	436.73	26	28	13.70	
	75	466	454.92	26	28	14.90	
	80	496	485.23	26	28	16.90	
	90	557	545.85	26	28	21.40	

K 60A
 SPROCKETS mm
 Tooth width (T) 11.7
 CHAIN mm
 Pitch (P) 19.05
 Internal width 12.70
 Roller Φ (Dr) 11.91

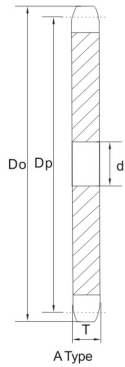

Stock Bore Platewheels (K)
Asian Standard Series

K 80A

Type	Teeth	Do	Dp	Bore d		Wt kg	Material
				Stock	Min		
K 80A	10	93	82.19	16	18	0.60	C45 Solid
	11	102	90.16	16	18	0.73	
	12	110	98.14	16	18	0.83	
	13	118	106.14	16	18	1.00	
	14	127	114.15	16	18	1.16	
	15	135	122.17	20	22	1.30	
	16	143	130.20	20	22	1.50	
	17	151	138.23	20	22	1.70	
	18	159	146.27	20	22	1.90	
	19	167	154.32	20	22	2.10	
	20	176	162.37	20	22	2.35	
	21	184	170.42	20	22	2.57	
	22	192	178.48	26	28	2.82	
	23	200	186.54	26	28	3.10	
	24	208	194.60	26	28	3.35	
	25	216	202.66	26	28	3.65	
	26	224	210.72	26	28	3.95	
	27	233	218.79	26	28	4.25	
	28	241	226.86	26	28	4.60	
	29	249	234.93	26	28	4.93	
	30	257	243.00	26	28	5.30	
	31	265	251.07	26	28	5.63	
	32	273	259.14	26	28	6.00	
	33	281	267.21	26	28	6.40	
	34	289	275.29	26	28	6.80	
	35	297	283.36	26	28	7.20	
	36	306	291.43	26	28	7.60	
	37	314	299.51	26	28	8.00	
	38	322	307.58	26	28	8.50	
	39	330	315.66	26	28	8.90	
	40	338	323.74	26	28	9.40	
	41	346	331.81	26	28	9.90	
	42	354	339.89	26	28	10.30	
	43	362	347.97	26	28	10.80	
	44	370	356.04	26	28	11.40	
	45	378	364.12	26	28	11.90	
	46	387	372.20	26	28	12.40	
	47	395	380.28	26	28	12.95	
	48	403	388.36	26	28	13.50	
	49	411	396.44	26	28	14.08	
	50	419	404.52	26	28	14.70	
	52	435	420.68	26	28	15.86	
	53	443	428.76	26	28	16.48	
	54	451	436.84	26	28	17.10	
	55	459	444.92	26	28	17.75	
	56	468	453.00	26	28	18.40	
	57	476	461.08	26	28	19.07	
	58	484	469.16	26	28	19.75	
	60	500	485.33	26	28	21.10	
	64	532	517.65	26	28	24.05	
	65	540	525.73	26	28	24.80	
	66	548	533.82	26	28	25.58	
	70	581	566.15	26	28	29.80	
	75	621	608.56	26	28	33.10	
	80	662	646.97	26	28	37.60	
	90	743	727.80	26	28	47.60	

K 80A
 SPROCKETS mm
 Tooth width (T) 14.6
 CHAIN mm
 Pitch (P) 25.4
 Internal width 15.88
 Roller Φ (Dr) 15.88

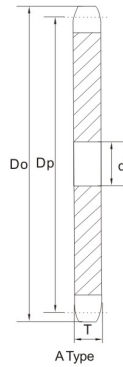

Stock Bore Platewheels (K)
Asian Standard Series

K 100A

Type	Teeth	Do	Dp	Bore d		Wt kg	Material
				Stock	Min		
K 100A	10	117	102.74	20	22	1.10	C45 Solid
	11	127	112.70	20	22	1.30	
	12	138	122.67	20	22	1.60	
	13	148	132.67	20	22	1.90	
	14	158	142.68	20	22	2.15	
	15	168	152.71	20	22	2.50	
	16	179	162.74	20	22	2.83	
	17	189	172.79	20	22	3.20	
	18	199	182.84	20	22	3.60	
	19	209	192.90	20	22	4.00	
	20	220	202.96	20	22	4.40	
	21	230	213.03	20	22	4.90	
	22	240	223.10	20	22	5.35	
	23	250	233.17	20	22	5.80	
	24	260	243.25	20	22	6.40	
	25	270	253.32	20	22	6.90	
	26	281	263.40	20	22	7.50	
	27	291	273.49	20	22	8.10	
	28	301	283.57	20	22	8.70	
	29	311	293.66	20	22	9.30	
	30	321	303.75	26	28	10.00	
	31	331	313.83	26	28	10.63	
	32	341	323.92	26	28	11.35	
	33	352	334.01	26	28	12.00	
	34	362	344.11	26	28	12.80	
	35	372	354.20	26	28	13.50	
	36	382	364.29	26	28	14.40	
	37	392	374.38	26	28	15.10	
	38	402	384.48	26	28	16.00	
	39	412	394.57	26	28	16.80	
	40	422	404.67	26	28	17.70	
	41	433	414.77	26	28	18.60	
	42	443	424.86	26	28	19.50	
	43	453	434.96	26	28	20.50	
	44	463	445.06	26	28	21.45	
	45	473	455.16	26	28	22.40	
	46	483	465.25	26	28	23.40	
	48	503	485.45	26	28	25.50	
	50	524	505.65	26	28	27.70	
	52	544	525.85	26	28	29.90	
	54	564	546.05	26	28	32.30	
	60	625	606.66	26	28	39.90	
	65	675	657.17	26	28	46.80	
	70	726	707.68	26	28	54.30	
	75	777	758.20	26	28	62.30	
	80	827	808.71	26	28	70.90	
	90	928	909.75	26	28	89.58	

K 100A
 SPROCKETS mm
 Tooth width (T) 17.6
 CHAIN mm
 Pitch (P) 31.75
 Internal width 19.05
 Roller Φ (Dr) 19.05

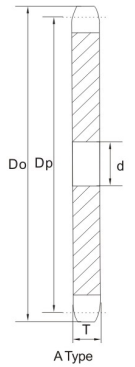

Stock Bore Platewheels (K)
Asian Standard Series

K 120A

K 120A

SPROCKETS mm
Tooth width (T) 23.5

CHAIN mm
Pitch (P) 38.10
Internal width 25.40
Roller Ø (Dr) 22.23

Type	Teeth	Do	Dp	Bore d		Wt kg	Material
				Stock	Min		
K 100A	10	140	123.29	20	22	2.16	C45 Solid
	11	153	135.24	20	22	2.60	
	12	165	147.21	20	22	3.10	
	13	177	159.20	20	22	3.60	
	14	190	171.22	20	22	4.20	
	15	202	183.25	20	22	4.80	
	16	214	195.29	20	22	5.50	
	17	227	207.35	20	22	6.20	
	18	239	219.41	20	22	6.95	
	19	251	231.48	20	22	7.70	
	20	263	243.55	20	22	8.55	
	21	276	255.63	20	22	9.40	
	22	288	267.72	26	28	10.30	
	23	300	279.80	26	28	11.30	
	24	312	291.90	26	28	12.30	
	25	324	303.99	26	28	13.30	
	26	337	316.09	26	28	14.40	
	27	349	328.19	26	28	15.50	
	28	361	340.29	26	28	16.70	
	29	373	352.39	26	28	17.80	
	30	385	364.50	26	28	19.20	
	31	398	376.60	26	28	20.40	
	32	410	388.71	26	28	21.80	
	33	422	400.82	26	28	23.20	
	34	434	412.93	26	28	24.60	
	35	446	425.04	26	28	26.10	
	36	458	437.15	26	28	27.60	
	38	463	461.38	26	28	30.80	
	40	507	485.60	26	28	34.10	
	42	531	509.84	26	28	37.60	
	44	556	534.07	26	28	41.20	
	45	568	546.19	26	28	43.10	
	46	580	558.30	26	28	45.10	
	48	604	582.54	26	28	49.00	
	50	628	606.78	26	28	53.30	
	54	677	655.26	26	28	62.10	
	60	750	727.99	26	28	76.70	
	70	871	849.22	26	28	104.30	
	75	932	909.84	26	28	119.80	
	80	993	970.66	26	28	136.30	

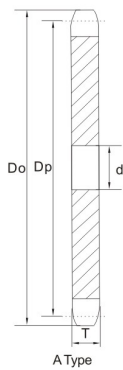

Stock Bore Platewheels (K)
Asian Standard Series

K 140A
K 160A

Type	Teeth	Do	Dp	Bore d		Wt kg	Material
				Stock	Min		
K 140A	10	163	143.84	26	28	2.90	C45 Solid
	11	178	157.78	26	28	3.60	
	12	193	171.74	26	28	4.20	
	13	207	185.74	26	28	4.90	
	14	221	199.76	26	28	5.70	
	15	236	213.79	26	28	6.60	
	16	250	227.84	26	28	7.50	
	17	264	241.91	26	28	8.40	
	18	279	255.98	26	28	9.40	
	19	293	270.06	26	28	10.50	
	20	307	284.15	26	28	11.60	
	21	322	298.24	26	28	12.80	
	22	336	312.34	26	28	14.10	
	23	350	326.44	26	28	15.30	
	24	364	340.54	26	28	16.70	
	25	379	354.65	26	28	18.10	
	26	393	368.77	26	28	19.60	
	28	421	397.00	26	28	23.00	
	30	450	425.24	26	28	26.00	
	32	478	453.49	26	28	29.70	
	35	521	495.88	26	28	35.60	
	38	563	538.27	26	28	41.90	
	40	591	566.54	26	28	46.40	
	42	620	594.81	26	28	51.10	
	45	662	637.22	26	28	58.80	
	48	705	679.63	26	28	66.90	
	50	733	707.91	26	28	72.50	
	54	790	764.47	26	28	84.60	
	60	875	849.32	26	28	104.00	

K 140A

SPROCKETS mm
Tooth width (T) 23.5

CHAIN mm
Pitch (P) 44.45
Internal width 25.40
Roller Ø (Dr) 25.40

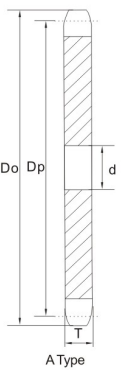

Type	Teeth	Do	Dp	Bore d		Wt kg	Material
				Stock	Min		
K 160A	10	186	164.39	26	28	4.85	C45 Solid
	11	204	180.31	26	28	5.85	
	12	220	196.28	26	28	6.90	
	13	237	212.27	26	28	8.10	
	14	253	228.30	26	28	9.40	
	15	269	244.33	26	28	10.80	
	16	286	260.39	26	28	12.25	
	17	302	276.46	26	28	13.80	
	18	319	292.55	26	28	15.50	
	19	335	308.64	26	28	17.20	
	20	351	324.74	26	28	19.00	
	21	368	340.84	26	28	21.00	
	22	384	356.96	26	28	23.00	
	23	400	373.07	26	28	25.10	
	24	416	389.19	26	28	27.40	
	25	433	405.32	26	28	29.70	
	26	449	421.45	26	28	32.10	
	28	481	453.72	26	28	37.20	
	30	514	485.99	26	28	42.70	
	32	546	518.28	26	28	48.70	
	35	595	566.71	26	28	58.10	
	38	644	615.17	26	28	68.50	
	40	676	647.47	26	28	75.10	
	42	708	679.78	26	28	83.60	
	45	757	728.25	26	28	96.00	
	48	806	776.72	26	28	109.00	
	50	838	809.04	26	28	118.50	
	54	903	873.68	26	28	138.20	
	60	1,000	970.65	26	28	170.00	

K 160A

SPROCKETS mm
Tooth width (T) 29.4

CHAIN mm
Pitch (P) 50.80
Internal width 31.75
Roller Ø (Dr) 28.58

Stock Bore Platewheels (K)
Asian Standard Series

**K 180A
K 200A**

Type	Teeth	Do	Dp	Bore d		Wt kg	Material
				Stock	Min		
K 180A	11	229	202.85	43	45	7.8	C45 Solid
	12	248	220.81	43	45	9.3	
	13	266	238.81	43	45	10.9	
	14	285	256.83	43	45	12.6	
	15	303	274.87	43	45	14.5	
	16	322	292.94	43	45	16.5	
	17	340	311.04	43	45	18.7	
	18	358	329.11	43	45	21.5	
	19	377	347.21	43	45	23.9	
	20	395	365.33	43	45	26.6	
	21	413	383.45	63	65	28.9	
	22	432	401.57	63	65	31.7	
	24	468	437.84	63	65	37.9	
	25	487	455.99	63	65	41.2	
	26	505	474.13	63	65	44.6	
	30	578	546.74	63	65	59.6	
	35	669	637.56	63	65	81.3	
	40	760	728.41	63	65	106.4	
	45	852	819.28	63	65	134.8	
	48	903	873.81	63	65	153.5	
60	1,125	1,091.98	63	65	240.2		

K 180A

SPROCKETS	mm
Tooth width (T)	33.0
CHAIN	mm
Pitch (P)	57.15
Internal width	35.72
Roller Φ (Dr)	35.71

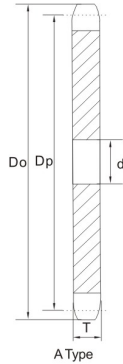

K 200A

SPROCKETS	mm
Tooth width (T)	35.3
CHAIN	mm
Pitch (P)	63.50
Internal width	37.85
Roller Φ (Dr)	69.68

Type	Teeth	Do	Dp	Bore d		Wt kg	Material
				Stock	Min		
K 200A	11	254	225.39	43	45	10.4	C45 Solid
	12	275	243.34	43	45	12.3	
	13	296	261.34	43	45	14.5	
	14	316	280.37	43	45	16.8	
	15	337	300.42	43	45	19.3	
	16	357	320.49	43	45	22.5	
	17	378	340.58	43	45	25.4	
	18	398	360.68	43	45	28.5	
	19	419	380.79	63	65	31.3	
	20	439	400.92	63	65	34.7	
	21	459	421.05	63	65	38.3	
	22	480	441.20	63	65	42.1	
	24	520	481.49	63	65	50.3	
	25	541	501.65	63	65	54.6	
	26	561	521.81	63	65	59.1	
	30	642	602.19	63	65	78.9	
	35	744	703.39	63	65	107.6	
	40	845	804.34	63	65	140.7	
	45	946	910.31	63	65	178.3	
	48	1,007	970.90	68	70	202.8	
60	1,250	1,213.31	68	70	317.3		

Double Pitch Sprockets
Asian Standard Series

**NK 2040SB
NK 2050SB
NK 2060SB**

NK 2040SB

SPROCKETS	mm
Tooth width (T)	7.2
CHAIN	mm
Pitch (P)	25.4
Internal width	7.95
Roller Φ (Dr)	7.95

Type	Teeth	Do	Dp	Bore d			BD	BL	Wt kg	Material
				Stock	Min	Max				
NK 2040SB	6 1/2	59	54.66	13	15	20	35	22	0.20	C45 Solid Hardened Teeth
	7 1/2	67	62.45	13	15	25	43	22	0.30	
	8 1/2	76	70.31	13	15	32	52	22	0.42	
	9 1/2	84	78.23	13	15	38	60	25	0.61	
	10 1/2	92	86.17	14	16	46	69	25	0.82	
	11 1/2	100	94.15	14	16	51	77	25	0.98	
12 1/2	108	102.14	14	16	42	63	25	0.83		

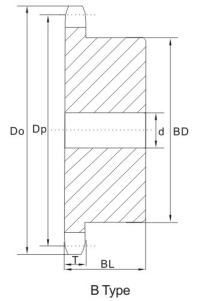

Type	Teeth	Do	Dp	Bore d			BD	BL	Wt kg	Material
				Stock	Min	Max				
NK 2050SB	6 1/2	74	68.32	14	16	25	44	25	0.38	C45 Solid Hardened Teeth
	7 1/2	84	78.06	14	16	32	54	25	0.55	
	8 1/2	94	87.89	14	16	45	65	25	0.76	
	9 1/2	105	97.78	14	16	48	73	28	1.06	
	10 1/2	115	107.72	14	16	48	73	28	1.16	
	11 1/2	125	117.68	16	18	48	73	28	1.27	
12 1/2	135	127.67	16	18	48	73	28	1.40		

NK 2050SB

SPROCKETS	mm
Tooth width (T)	8.7
CHAIN	mm
Pitch (P)	31.75
Internal width	9.53
Roller Φ (Dr)	10.16

Type	Teeth	Do	Dp	Bore d			BD	BL	Wt kg	Material
				Stock	Min	Max				
NK 2060SB	6 1/2	88	81.98	14	16	32	53	32	0.73	C45 Solid Hardened Teeth
	7 1/2	101	93.67	16	18	45	66	32	1.05	
	8 1/2	113	105.47	16	18	48	73	32	1.33	
	9 1/2	126	117.34	16	18	55	83	40	2.03	
	10 1/2	138	129.26	16	18	55	83	40	2.23	
	11 1/2	150	141.22	16	18	55	80	45	2.56	
12 1/2	162	153.20	16	18	55	80	45	2.81		

NK 2060SB

SPROCKETS	mm
Tooth width (T)	11.7
CHAIN	mm
Pitch (P)	38.10
Internal width	12.70
Roller Φ (Dr)	11.91